



Single/Dual, +3V/+5V Dual-Speed Comparators with Auto-Standby

MAX975/MAX977

General Description

The MAX975/MAX977 single/dual comparators feature three different operating modes, and are optimized for +3V and +5V single-supply applications. The operating modes are as follows: high speed, high speed with auto-standby, and low power. Propagation delay is 28ns in high-speed mode, while supply current is only 250 μ A. Supply current is reduced to 3 μ A in low-power mode.

The auto-standby feature allows the comparator to automatically change from low-power mode to high-speed mode upon receipt of an input signal. In the absence of an input signal, the comparator reverts back to low-power mode after an adjustable timeout period. The timeout period for the MAX975 to enter standby is set by a single capacitor. The dual MAX977 features independently adjustable timeout periods for each comparator using separate capacitors.

The MAX975/MAX977's inputs have a common-mode voltage range of -0.2V to ($V_{CC} - 1.2V$). The differential input voltage range extends rail to rail. The outputs are capable of rail-to-rail operation without external pull-up circuitry, making these devices ideal for interface with CMOS/TTL logic. All inputs and outputs can tolerate a continuous short-circuit fault condition to either rail. The comparator's internal hysteresis in high-speed mode ensures clean output switching, even with slow-moving input signals.

The single MAX975 is available in 8-pin SO and 8-pin μ MAX[®] packages, while the dual MAX977 is available in 14-pin SO and 16-pin QSOP packages.

Applications

- Battery-Powered Systems
- RF ID Tags
- Keyless Entry
- Threshold Detectors/Discriminators
- 3V Systems
- IR Receivers
- Digital-Line Receivers

μ MAX is a registered trademark of Maxim Integrated Products, Inc.

Pin Configurations appear at end of data sheet.

Features

- ◆ Three Operating Modes:
 - High Speed
 - High Speed with Auto-Standby
 - Low Power
- ◆ 28ns Propagation Delay (high-speed mode)
- ◆ 5 μ A Max Supply Current in Low-Power/ Auto-Standby Modes
- ◆ +3V/+5V Single-Supply Operation
- ◆ Rail-to-Rail Outputs
- ◆ Ground-Sensing Input
- ◆ Internal Hysteresis (high-speed mode)
- ◆ Adjustable Timeout Period
- ◆ μ MAX Package (MAX975)
QSOP-16 Package (MAX977)

Ordering Information

PART	TEMP RANGE	PIN-PACKAGE	PKG CODE
MAX975ESA	-40°C to +85°C	8 SO	S8-2
MAX975EUA-T	-40°C to +85°C	8 μ MAX-8	U8-1
MAX977ESD	-40°C to +85°C	14 SO	S14-1
MAX977EEE	-40°C to +85°C	16 QSOP	E16-1

Functional Diagram

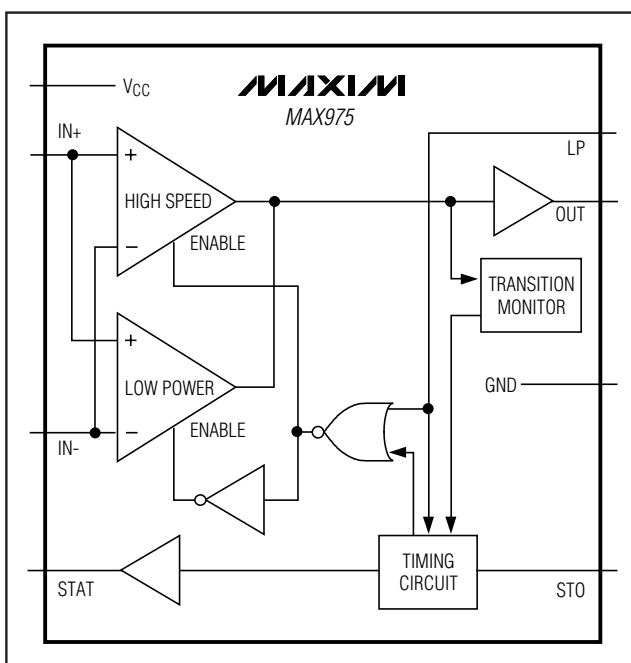

Maxim Integrated Products 1

For pricing, delivery, and ordering information, please contact Maxim/Dallas Direct! at 1-888-629-4642, or visit Maxim's website at www.maxim-ic.com.

Single/Dual, +3V/+5V Dual-Speed Comparators with Auto-Standby

ABSOLUTE MAXIMUM RATINGS

Supply Voltage (V _{CC})	+6V	8-Pin μ MAX (derate 4.10mW/°C above +70°C)	330mW
All Other Pins	-0.3V to (V _{CC} + 0.3V)	14-Pin SO (derate 8.33mW/°C above +70°C)	667mW
Current into Input Pins	± 20 mA	16-Pin QSOP (derate 8.33mW/°C above +70°C)	667mW
Duration of Output Short Circuit to GND ₁ or V _{CC}	Continuous	Operating Temperature Range	-40°C to +85°C
Continuous Power Dissipation (T _A = +70°C)		Storage Temperature Range	-65°C to +150°C
8-Pin SO (derate 5.88mW/°C above +70°C)	471mW	Lead Temperature (soldering, 10sec)	+300°C

Stresses beyond those listed under "Absolute Maximum Ratings" may cause permanent damage to the device. These are stress ratings only, and functional operation of the device at these or any other conditions beyond those indicated in the operational sections of the specifications is not implied. Exposure to absolute maximum rating conditions for extended periods may affect device reliability.

ELECTRICAL CHARACTERISTICS

(V_{CC} = +2.7V to +5.25V, specifications are for high-speed mode, T_A = -40°C to +85°C, unless otherwise noted. Typical values are at T_A = +25°C.) (Note 1)

PARAMETER	SYMBOL	CONDITIONS		MIN	TYP	MAX	UNITS
POWER SUPPLY							
Supply-Voltage Operating Range	V _{CC}			2.7		5.25	V
Supply Current Per Comparator	I _{CC}	High-speed mode			250	500	μ A
		Auto-standby/low-power modes	SO		3	5	
				μ MAX/QSOP		3	6
Power-Supply Rejection Ratio	PSRR	V _{CM} = 1V, 2.7V \leq V _{CC} \leq 5.25V	High-speed mode	63	90		dB
			Low-power mode		77		
COMPARATOR INPUTS							
Common-Mode Voltage Range	V _{CMR}	(Note 2)		-0.2		V _{CC} - 1.2	V
Input Offset Voltage (Note 3)	V _{OS}	V _{CM} = 1V, V _{CC} = 5V	High-speed mode, T _A = +25°C		+0.2	± 2	mV
			High-speed mode, T _A = T _{MIN} to T _{MAX}			± 3	
			Auto-standby/ low-power modes, T _A = T _{MIN} to T _{MAX}	SO		± 1	
μ MAX/QSOP		± 1		± 7			
Input-Referred Hysteresis	V _{HYS}	V _{CM} = 1V, V _{CC} = 5V (Note 4)	SO	0.5	2	4	mV
			μ MAX/QSOP	0.3	2	4	
Input Bias Current	I _B	High-speed mode	SO	-100	-300		nA
			μ MAX/QSOP	-100	-400		
		Auto-standby/low-power modes		-5			
Input Offset Current	I _{OS}				± 20	± 100	nA
Input Capacitance	C _{IN}				3		pF
Common-Mode Rejection Ratio	CMRR	-0.2V \leq V _{CM} \leq V _{CC} - 1.2V	High-speed mode	SO	66	90	dB
				μ MAX/QSOP	54		
			Low-power mode		82		

Single/Dual, +3V/+5V Dual-Speed Comparators with Auto-Standby

MAX975/MAX977

ELECTRICAL CHARACTERISTICS (continued)

($V_{CC} = +2.7V$ to $+5.25V$, specifications are for high-speed mode, $T_A = -40^{\circ}C$ to $+85^{\circ}C$, unless otherwise noted. Typical values are at $T_A = +25^{\circ}C$.) (Note 1)

PARAMETER	SYMBOL	CONDITIONS		MIN	TYP	MAX	UNITS
DIGITAL INPUTS							
LP Input Voltage High	V_{LPIH}			$0.7 \times V_{CC}$	$V_{CC} / 2$		V
LP Input Voltage Low	V_{LPIL}				$V_{CC} / 2$	$0.3 \times V_{CC}$	V
LP Fall Time	t_{LP}	(Note 5)				10	μs
LP Input Current	I_{LPB}				0.01	± 1	μA
STO_ Input Voltage Low	V_{CIL}				$V_{CC} / 2$	$0.3 \times V_{CC}$	V
STO_ Source Current	I_{STO}	$V_{CC} = 3V$			0.15		μA
DIGITAL OUTPUTS							
OUT_ Output Voltage High	V_{OH}	$I_{SOURCE} = 2mA$, all modes		$V_{CC} - 0.4$	$V_{CC} - 0.1$		V
OUT_ Output Voltage Low	V_{OL}	$I_{SINK} = 2mA$, all modes			0.1	0.4	V
Propagation Delay, Low to High (Note 6)	t_{PD+}	$C_{LOAD} = 10pF$, $V_{CC} = 5V$	High-speed mode, overdrive = 5mV		28	50	ns
			Low-power mode, overdrive = 10mV		0.82	1.6	μs
Propagation Delay, High to Low (Note 6)	t_{PD-}	$C_{LOAD} = 10pF$, $V_{CC} = 5V$	High-speed mode, overdrive = 5mV		28	50	ns
			Low-power mode, overdrive = 10mV		0.48	1.6	μs
Propagation-Delay Skew (Note 6)	t_{SKEW}	$C_{LOAD} = 10pF$			2		ns
Propagation-Delay Matching	Δt_{PD}	MAX977 only, $C_{LOAD} = 10pF$			1		ns
Rise/Fall Time		$C_{LOAD} = 10pF$, $V_{CC} = 5.0V$	High-speed mode		1.6		ns
			Low-power mode		1.6		
STAT_ Output Voltage High	V_{SH}	$I_{SOURCE} = 3mA$, all modes		$V_{CC} - 0.4$			V
STAT_ Output Voltage Low	V_{SL}	$I_{SINK} = 400\mu A$, all modes				0.4	V

Note 1: The MAX975EUA is 100% production tested at $T_A = +25^{\circ}C$; all temperature specifications are guaranteed by design.

Note 2: Inferred by CMRR. Either input can be driven to the absolute maximum limit without false output inversion, as long as the other input is within the specified common-mode input voltage range.

Note 3: V_{OS} is defined as the mean of trip points. The trip points are the extremities of the differential input voltage required to make the comparator output change state (Figure 1).

Note 4: The difference between the upper and lower trip points is equal to the width of the input-referred hysteresis zone (Figure 1).

Note 5: Guaranteed by design. The LP pin is sensitive to noise. If fall times larger than $10\mu s$ are expected, bypass LP to ground using a $0.1\mu F$ capacitor.

Note 6: Propagation delay is guaranteed by design. For low-overdrive conditions, V_{OS} is added to the overdrive. The following equation defines propagation-delay skew: $t_{SKEW} = t_{PD+} - t_{PD-}$.

Single/Dual, +3V/+5V Dual-Speed Comparators with Auto-Standby

ELECTRICAL CHARACTERISTICS (continued)

($V_{CC} = +2.7V$ to $+5.25V$, specifications are for high-speed mode, $T_A = -40^{\circ}C$ to $+85^{\circ}C$, unless otherwise noted. Typical values are at $T_A = +25^{\circ}C$.) (Note 1)

PARAMETER	SYMBOL	CONDITIONS	MIN	TYP	MAX	UNITS
AUTO-STANDBY/LOW-POWER TIMING (Note 7; Figure 2)						
Auto-Standby Timeout	t_{ASB}	(Note 8)	5	10	16	ms
Auto-Standby Enable Time	t_{ASBE}	(Note 9)		3		μs
Auto-Standby Wake-Up Time	t_{ASD}	10mV overdrive (Note 10)		2	4	μs
Auto-Standby Wake-Up Input or LP Pulse Width	t_{PWD}	10mV overdrive (Note 11)	1.6			μs
Auto-Standby Comparator Disable	t_{ASCD}	(Note 12)		0.8		μs
Low-Power Enable Time	t_{LPE}	(Note 13)		3		μs
High-Speed Enable Time	t_{HSE}	(Note 14)		1.1	4	μs
Low-Power Comparator Disable	t_{LPCD}	(Note 15)		0.7		μs
Low-Power STAT_High	t_{LPSH}	(Note 16)		20		ns

Note 7: Timing specifications are guaranteed by design.

Note 8: Set by 1000pF external capacitor at the STO_ pin. t_{ASB} is defined as the time from last input transition to STAT_ = high. Does not include time to go into standby condition (t_{ASBE}).

Note 9: t_{ASBE} is defined as the time from when STAT_ goes high to when the supply current drops to 5 μA .

Note 10: t_{ASD} is defined as the time from the last input transition to when STAT_ goes low. The comparator is in high-speed mode before STAT_ is low.

Note 11: t_{PWD} is defined as the minimum input or LP pulse width to trigger fast-mode operation from auto-standby.

Note 12: t_{ASCD} is defined as the time from the last input transition to when the supply current increases to 300 μA .

Note 13: t_{LPE} is defined as the time from when LP is driven high to when the supply current drops to 5 μA .

Note 14: t_{HSE} is defined as the time from when LP goes low to when STAT goes low. The comparator is in high-speed mode before STAT_ is low.

Note 15: t_{LPCD} is defined as the time from when LP goes low to when the supply current increases to 300 μA .

Note 16: t_{LPSH} is defined as the time from when LP goes high to when STAT_ goes high.

Single/Dual, +3V/+5V Dual-Speed Comparators with Auto-Standby

Typical Operating Characteristics

($V_{CC} = 3.0V$, $T_A = +25^\circ C$, unless otherwise noted.)

MAX975/MAX977

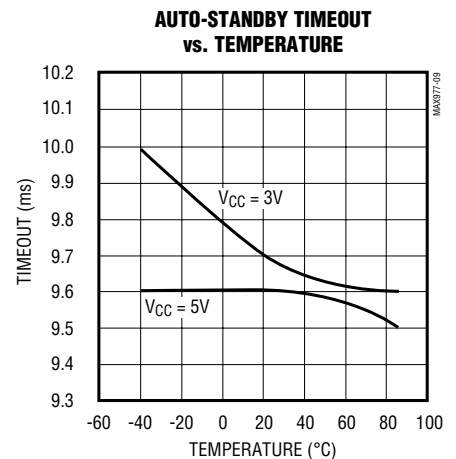
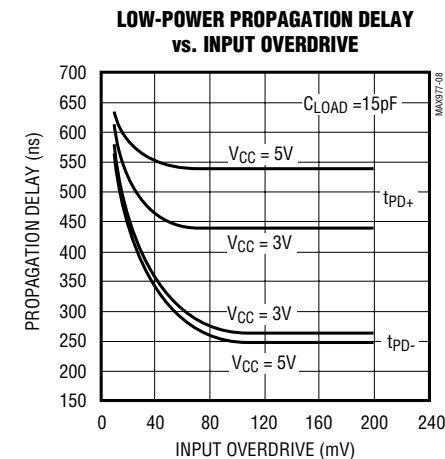
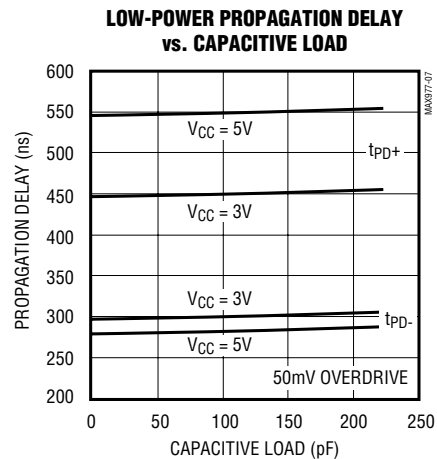
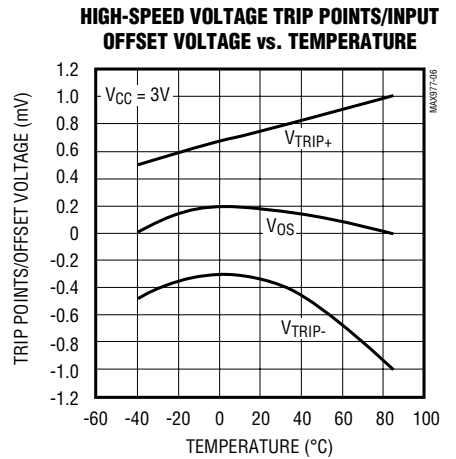
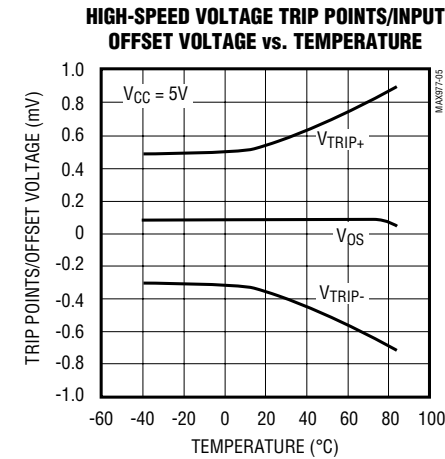
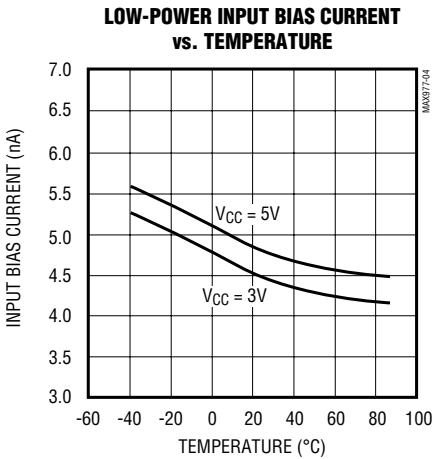
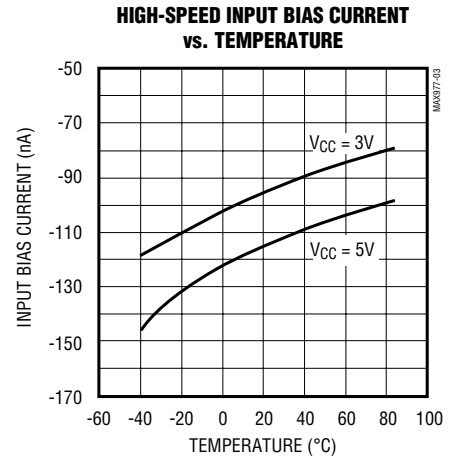
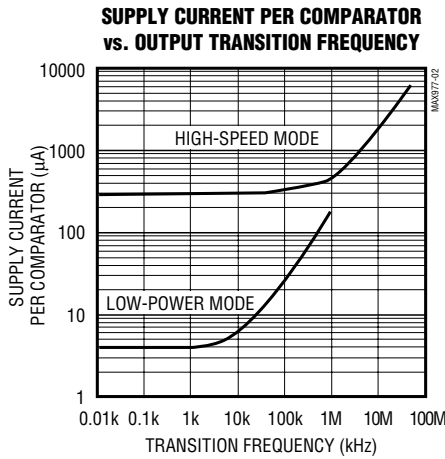
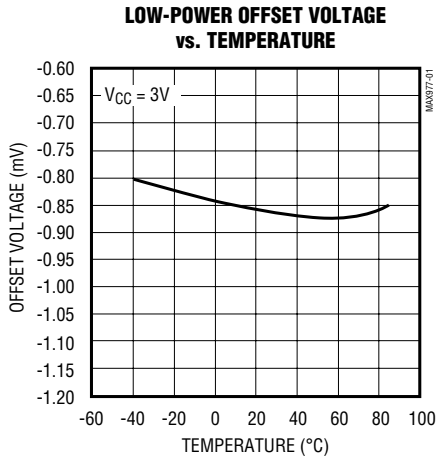

Single/Dual, +3V/+5V Dual-Speed Comparators with Auto-Standby

Typical Operating Characteristics (continued)

($V_{CC} = 3.0V$, $T_A = +25^\circ C$, unless otherwise noted.)

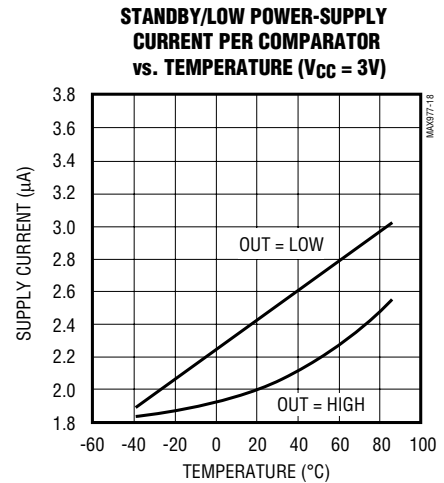
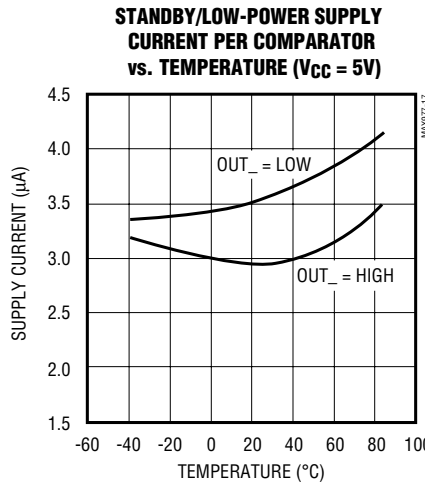
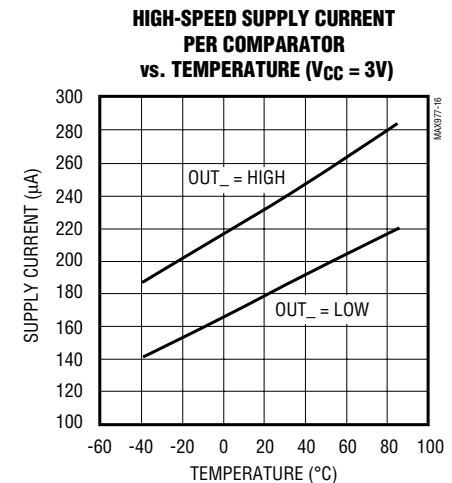
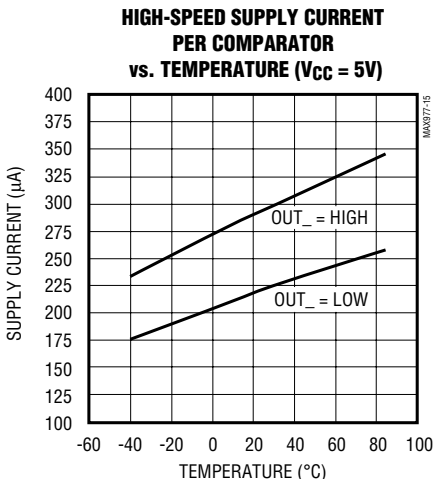
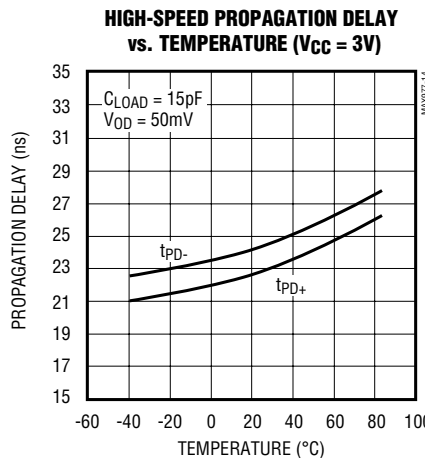
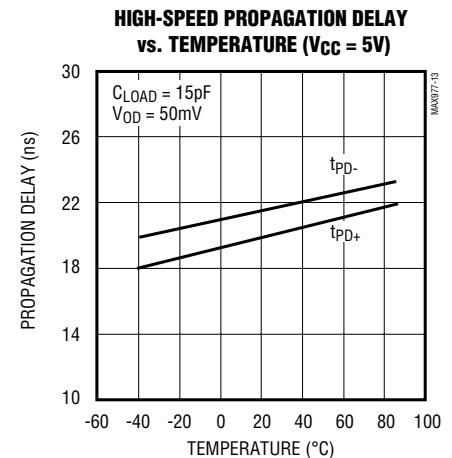
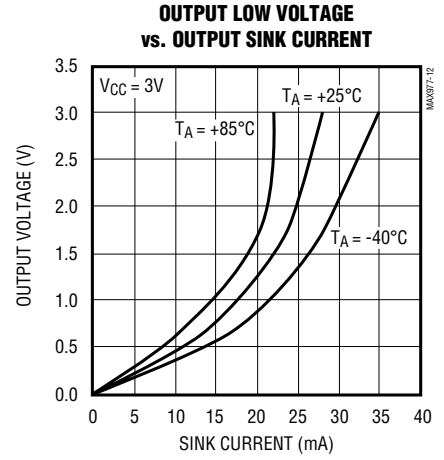
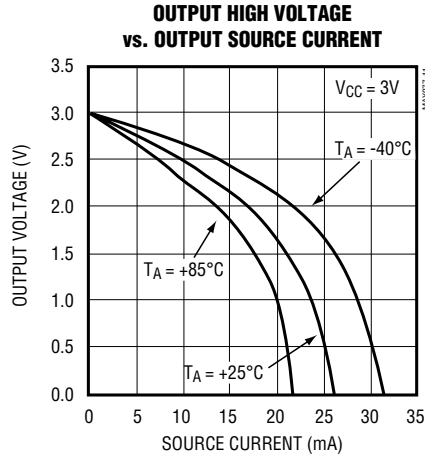
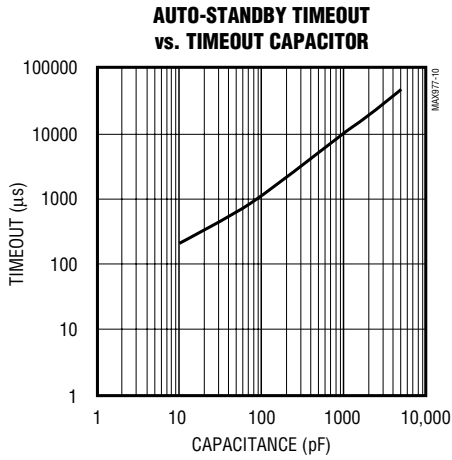

Single/Dual, +3V/+5V Dual-Speed Comparators with Auto-Standby

Typical Operating Characteristics (continued)

($V_{CC} = 3.0V$, $T_A = +25^\circ C$, unless otherwise noted.)

MAX975/MAX977

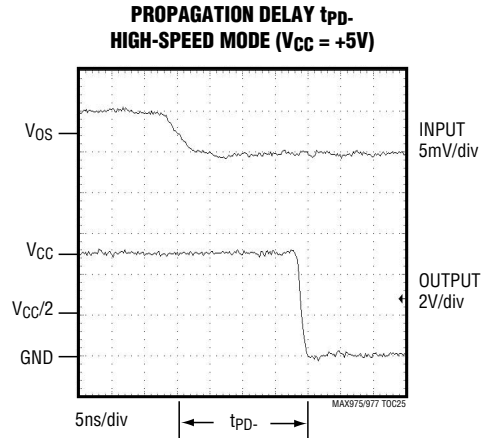
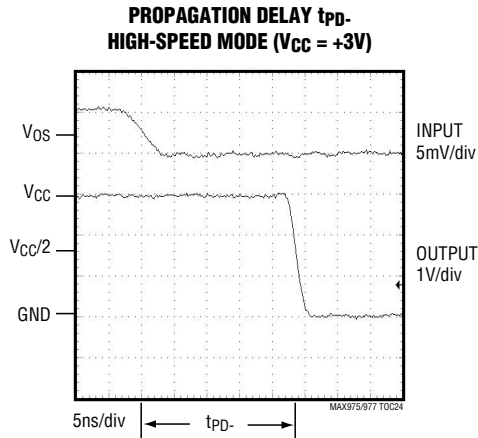
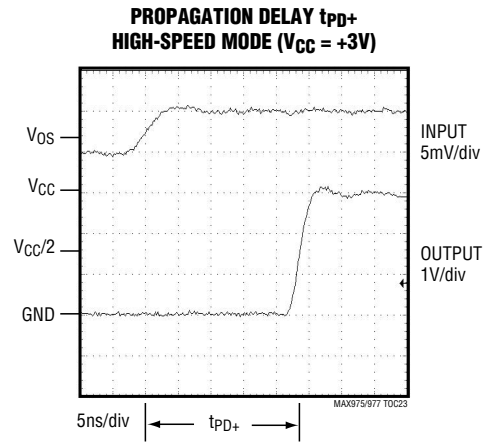
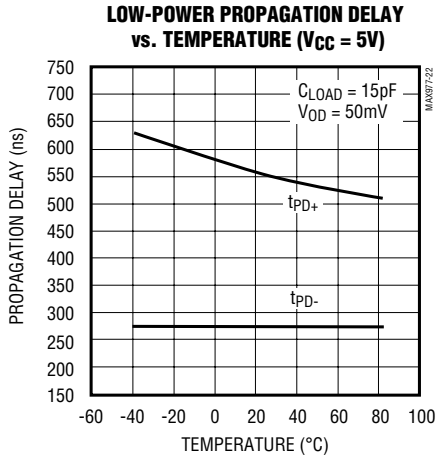
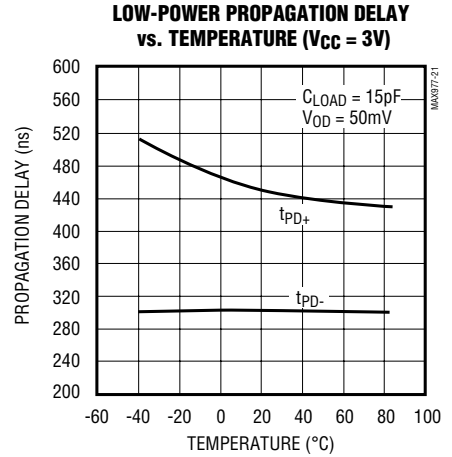
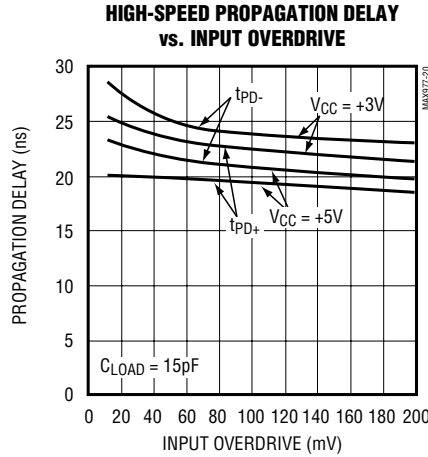
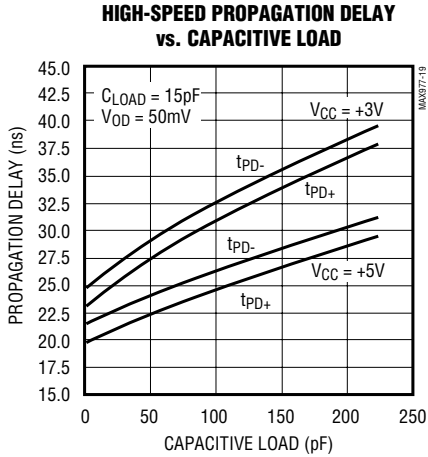

Single/Dual, +3V/+5V Dual-Speed Comparators with Auto-Standby

Typical Operating Characteristics (continued)

($V_{CC} = 3.0V$, $T_A = +25^\circ C$, unless otherwise noted.)

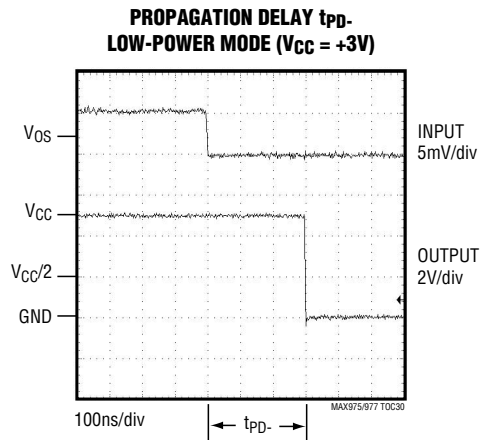
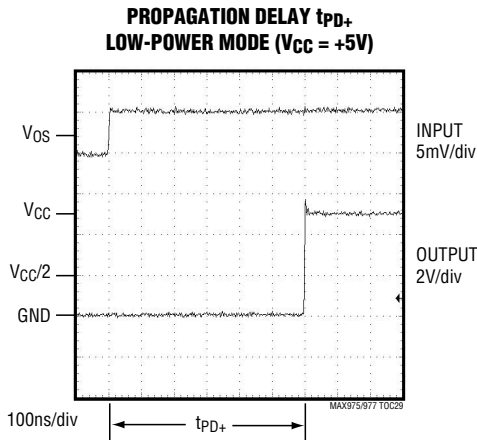
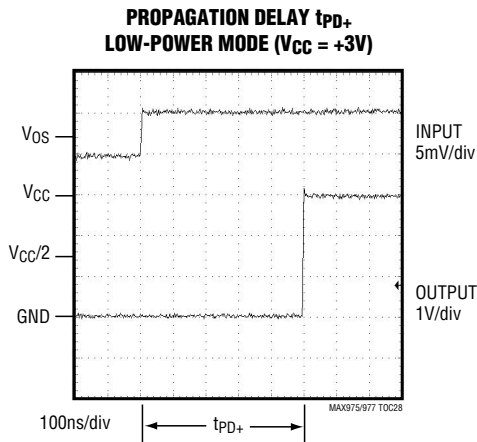
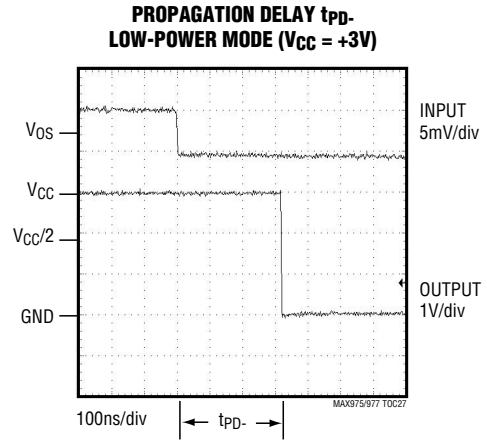
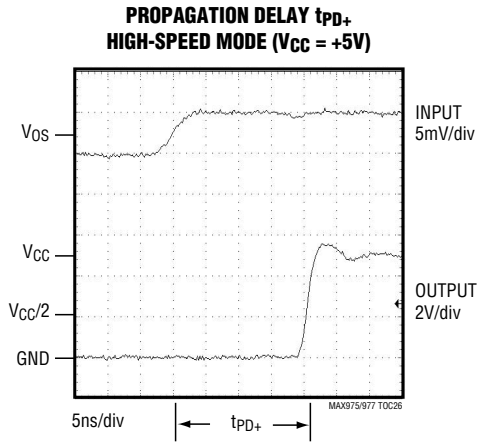

Single/Dual, +3V/+5V Dual-Speed Comparators with Auto-Standby

MAX975/MAX977

Typical Operating Characteristics (continued)

($V_{CC} = 3.0V$, $T_A = +25^\circ C$, unless otherwise noted.)

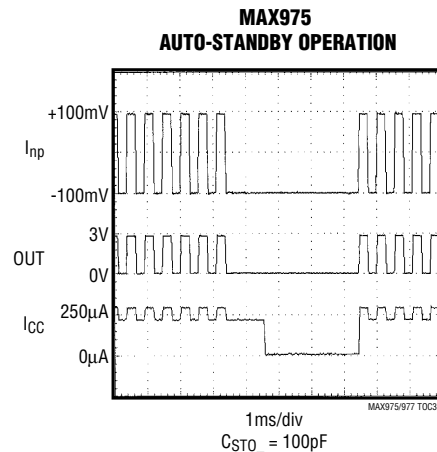
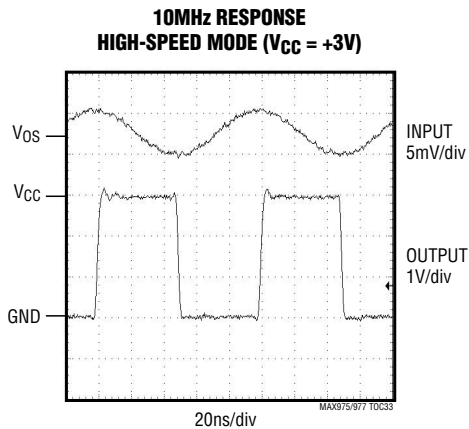
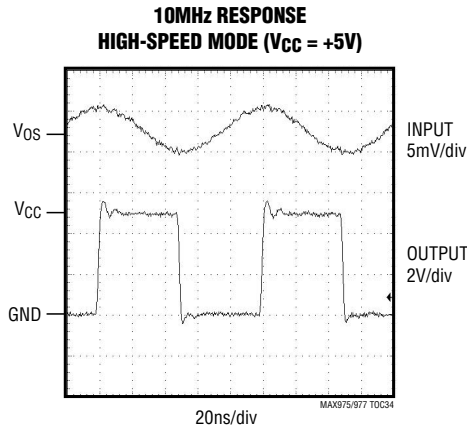
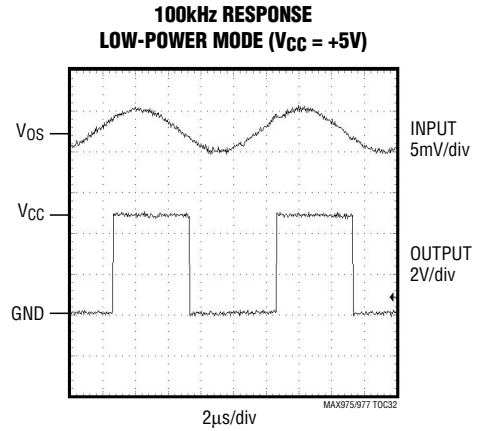
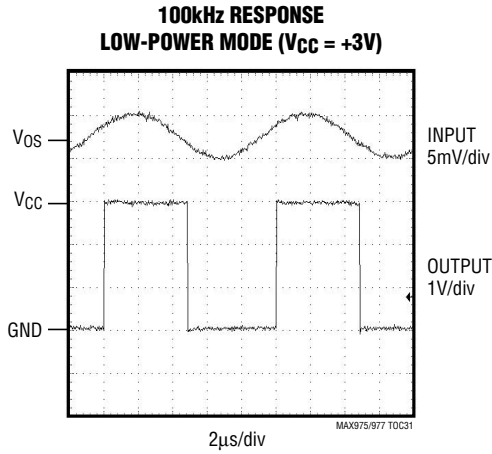

Single/Dual, +3V/+5V Dual-Speed Comparators with Auto-Standby

Pin Descriptions

MAX975

PIN	NAME	FUNCTION
1	V _{CC}	Positive Supply Voltage, +2.7V to +5.25V
2	IN+	Noninverting Comparator Input
3	IN-	Inverting Comparator Input
4	STAT	Mode Status Pin. Indicates the operating mode. STAT is high for auto-standby mode or low-power mode, and during the transition to high-speed mode. STAT = low indicates that the comparator is in high-speed mode. STAT can source 3mA to power additional circuitry.
5	STO	Set Timeout Input. Connect a capacitor from STO to GND to program the time the comparator may remain idle before entering standby mode. Connect STO to GND to disable the auto-standby feature. Calculate timeout with the following relationship: $t_{ASB} = 10 \times C \mu s$, where C is in pF.
6	GND	Ground
7	OUT	Comparator Output
8	LP	Low Power Mode Input. Drive LP high for low-power mode. Drive LP low for high-speed mode (STO = GND) or for high-speed mode with auto-standby. Connect to GND if low-power mode will not be used. Connect to V _{CC} if high-speed mode will not be used.

MAX977

SO	QSOP	NAME	FUNCTION
1, 8	1, 9	STOA, STOB	Set Idle Timeout Input A/B. Connect a capacitor from STOA/STOB to GND to program the time in which comparator A/B may remain idle before entering standby mode. Connect STOA/STOB to GND to disable the auto-standby feature for comparator A/B. Calculate timeout with the following relationship: $t_{ASB} = 10 \times C \mu s$, where C is in pF.
2, 9	2, 10	GNDA, GNDB	Ground for Comparator A/B
3, 10	3, 11	OUTA, OUTB	Output for Comparator A/B
4	4, 5	V _{CC}	Positive Supply Voltage, +2.7V to +5.25V. For QSOP, connect pin 4 to pin 5.
5, 12	6, 14	INB+, INA+	Noninverting Input for Comparator B/A
6, 13	7, 15	INB-, INA-	Inverting Input for Comparator B/A
7, 14	8, 16	STATB, STATA	Mode Status Pin B/A. Indicates the operating mode of comparator B/A. STATB/STATA is high for auto-standby mode or for low-power mode, and during the transition to high-speed mode. STATB/STATA = low indicates that comparator B/A is in high-speed mode. STATB/STATA can source 3mA to power additional circuitry.
—	12	N.C.	No Connection. Not internally connected.
11	13	LP	Low Power Mode Input for both comparators. Drive LP high for low-power mode. Drive LP low for high-speed mode (STO_ = GND) or for high-speed mode with auto-standby. Connect to GND if low-power mode will not be used. Connect to V _{CC} if high-speed mode will not be used.

Single/Dual, +3V/+5V Dual-Speed Comparators with Auto-Standby

Table 1. Programming

INPUTS			MODE	STAT OUTPUT
LP	STO_	IDLE TIME		
L	$t_{ASB} = C_{STO} \times 10\mu s/pF$	$<t_{ASB}$	High speed (Auto-standby enabled)	L
L	$t_{ASB} = C_{STO} \times 10\mu s/pF$	$\geq t_{ASB}$	Auto-standby	H
↓ (falling edge)	L	X	High speed (Auto-standby mode disabled)	L
H	X	X	Low power	H

Detailed Description

The MAX975/MAX977 single/dual comparators have three operating modes, and use a +2.7V to +5.25V single supply. The operating modes are as follows: high speed, high speed with auto-standby, and low power. Propagation delay is typically 28ns in high-speed mode, while typical supply current is 250µA. In low-power mode, propagation delay is typically 480ns and power consumption is only 3µA. The auto-standby feature switches into low-power standby for each comparator with unchanging outputs in high-speed mode. The timeout period, or the time that OUT_ must be idle (unchanged state) for the MAX975/MAX977 to enter auto-standby, is adjustable by means of an external capacitor. All inputs and outputs can tolerate a continuous short-circuit fault condition to either rail. Internal hysteresis in high-speed mode ensures clean output switching, even with slow-moving input signals.

The MAX975 functional diagram shows two paralleled comparators, a timing circuit, a transition detector, and logic gates. The upper comparator is high speed, while the lower comparator is a slower low-power comparator. The dual MAX977 features independent timeout adjustment. The following sections discuss the details of operation.

Hysteresis (High-Speed Mode Only)

Most high-speed comparators can oscillate in the linear operating region because of noise or undesired parasitic feedback. This tends to occur when the voltage on one input is equal to or very close to the voltage on the other input. The MAX975/MAX977 have internal hysteresis to counter parasitic effects and noise.

The hysteresis in a comparator creates two trip points: one for the rising input voltage and one for the falling

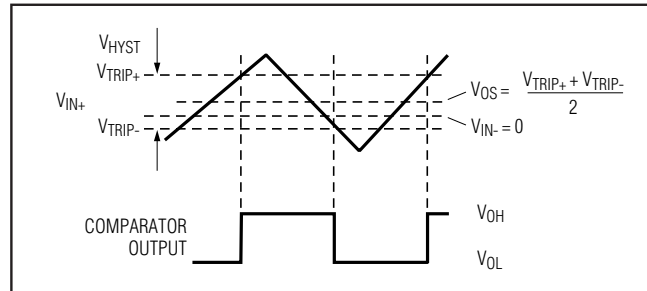

Figure 1. Input and Output Waveforms, Noninverting Input Varied

input voltage (Figure 1). The difference between the trip points is the hysteresis. When the comparators' input voltages are equal, the hysteresis effectively causes one comparator input voltage to move quickly past the other, taking the input out of the region where oscillation occurs.

Figure 1 illustrates the case where IN- has a fixed voltage applied and IN+ is varied. If the inputs were reversed, the figure would be the same, except with an inverted output.

Auto-Standby Mode

The MAX975/MAX977's auto-standby function operates only in high-speed mode. The device enters auto-standby when OUT_ remains unchanged for a preprogrammed timeout period. In auto-standby mode, the low-power comparator is enabled while the high-speed comparator is disabled and STAT_ goes high. The logic state and sink/source capabilities of OUT_ remain unchanged, but propagation delay increases to 480ns. In this mode, the timing circuitry is powered down, and the transition detector monitors the low-power comparator for a transition. When an output transition occurs (OUT_ changes state), the timing circuitry is

Single/Dual, +3V/+5V Dual-Speed Comparators with Auto-Standby

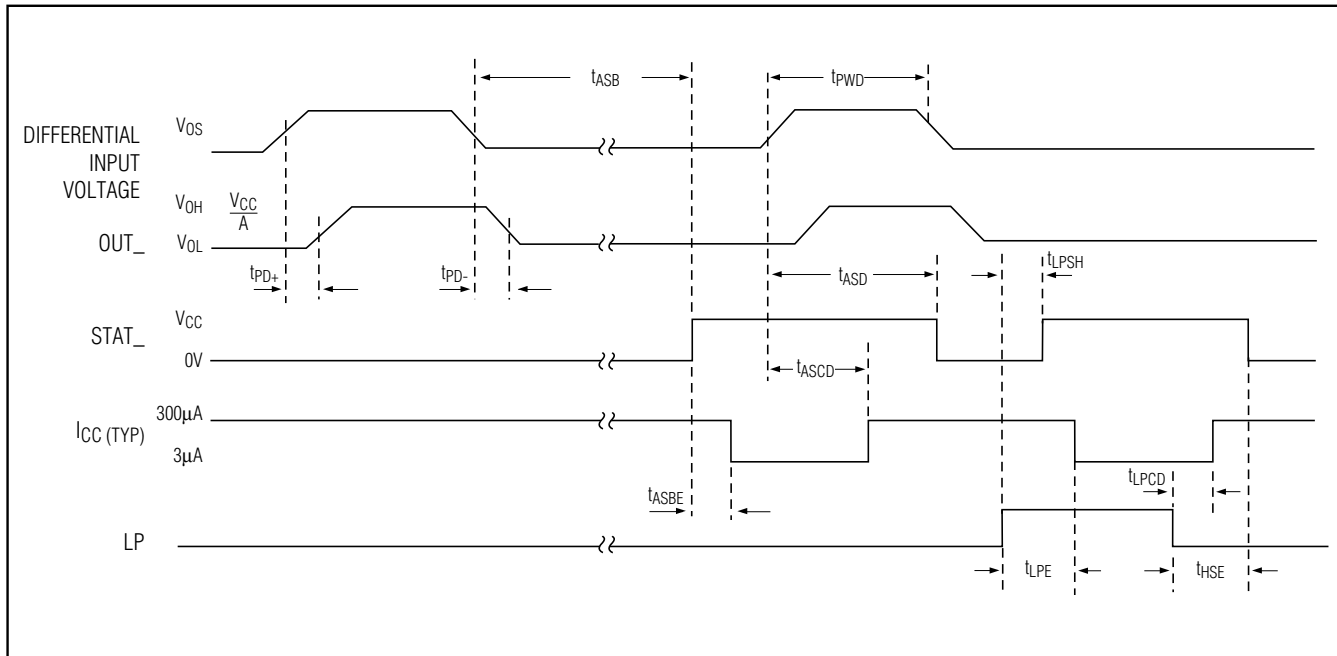

Figure 2. Timing Diagram

powered up, the high-speed comparator is enabled, the low-power comparator is disabled, and STAT goes high, placing the MAX975 back into high-speed mode (Figure 2).

Use an external capacitor, C_{STO} , to program the timeout period required for the comparator to enter auto-standby mode. Determine the capacitor required for a particular timeout period by the relationship $t_{ASB} = 10 \times C_{\mu s}$, where C is in pF. For example, connecting a $0.1\mu F$ capacitor to STO_+ results in a timeout period of 1sec. The propagation delay of OUT_+ when exiting auto-standby mode is equivalent to the low-power-mode propagation delay. When $STAT_+$ goes low, the low-power comparator is disabled and the high-speed comparator is ready for operation. To bring the comparator out of auto-standby mode without a transition occurring on OUT_+ , toggle LP low-high-low. The LP pin is sensitive to noise. If fall times larger than $10\mu s$ are expected, bypass LP with a $0.1\mu F$ capacitor to GND. To disable auto-standby mode, drive STO_+ low or connect it to ground. Note that driving STO_+ low while in auto-standby mode will not bring the comparator out of auto-standby mode. Also, if driving STO_+ with an open drain, leakage must be less than $1nA$. On power-up, the device is in high-speed mode unless LP is high. The MAX977 operates in the same manner as the MAX975.

Low-Power Mode

Driving LP high switches the MAX975/MAX977 to low-power mode. In this mode, the supply current drops to a maximum of $5\mu A$, and propagation delay increases typically to $480ns$. The high-speed comparator is disabled and the low-power comparator is enabled for continuous operation. Return to high-speed mode by driving LP low. The LP pin is sensitive to noise. If fall times larger than $10\mu s$ are expected, bypass LP with a $0.1\mu F$ capacitor to GND. The logic state and sink/source capabilities of OUT_+ remain unchanged in low-power mode.

Input-Stage Circuitry

The MAX975/MAX977 input common-mode range is from $-0.2V$ to $(V_{CC} - 1.2V)$. But the voltage range for each comparator input extends to both V_{CC} and GND rails. The output remains in the correct logic state while one or both of the inputs are within the common-mode range. If both input levels are out of the common-mode range, input-stage current saturation occurs and the output becomes unpredictable.

Single/Dual, +3V/+5V Dual-Speed Comparators with Auto-Standby

Applications Information

Powering Circuitry with STAT

STAT's function is to indicate the comparator's operating mode. When STAT is low, the comparator is in high-speed mode and will meet the guaranteed propagation delay. When STAT is high, the comparator is in auto-standby mode, in low-power mode, or in transition to high-speed mode. An additional feature of this pin is that it can source 3mA of current. When STAT is high, additional circuitry can be powered. This circuitry can be automatically powered up or powered down, depending on the input signal or lack of input signal received by the MAX975/MAX977.

STO_ Considerations

The charge currents for the capacitor connected to STO_ are on the order of 100nA. This necessitates caution in capacitor type selection and board layout. Capacitor leakage currents must be less than 1nA to prevent timing errors. Ceramic capacitors are available in values up to 1μF, and are an excellent choice for this application. If a larger capacitance value is needed, use parallel ceramic capacitors to get the required capacitance. Aluminum and tantalum electrolytic capacitors are not recommended due to their higher leakage currents.

Board layout can create timing errors due to parasitic effects. Make the STO_ traces as short as possible to reduce capacitance and coupling effects. When driving STO_ to disable auto-standby mode, use standard CMOS logic isolated with a low-leakage (<1nA) diode, such as National's FJT1100 (Figure 3). 15nA leakage typically results in 10% error.

The MAX977 has separate timing inputs (STOA and STOB). These pins must have separate capacitors. The timing circuits will not operate correctly if a single capacitor is used with STOA and STOB connected together.

The relationship between the timeout period and the STO_ capacitor is $t_{ASB} = 10 \times C_{STO_} \mu s$, where $C_{STO_}$ is in pF. This equation is for larger capacitance values, and does not take into account variations due to board capacitance and board leakage. If less than 1ms is desired, subtract the ~3pF STO_ parasitic capacitance from the calculated value.

Circuit Layout and Bypassing

The MAX975/MAX977's high gain bandwidth requires design precautions to realize the comparator's full high-speed capability. The following precautions are recommended:

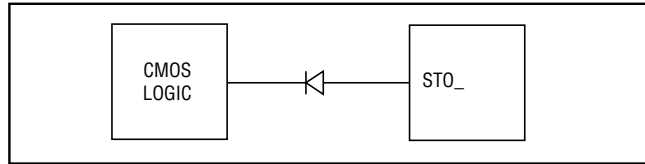

Figure 3. Driving STO_ with CMOS Logic

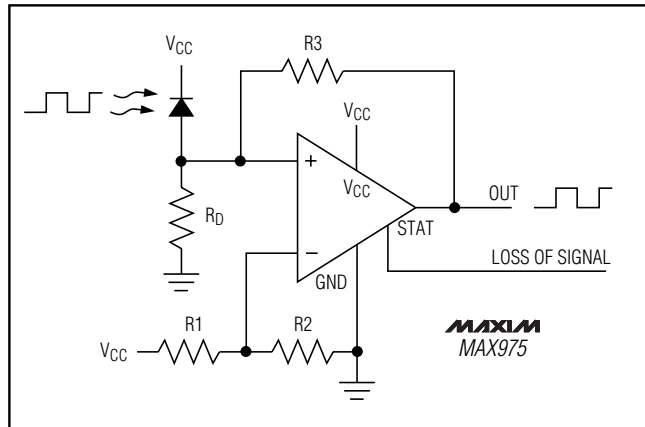

Figure 4. IR Receiver

- 1) Use a printed circuit board with an unbroken, low-inductance ground plane.
- 2) Place a decoupling capacitor (a 0.1μF ceramic capacitor is a good choice) as close to VCC as possible.
- 3) Keep lead lengths short on the inputs and outputs, to avoid unwanted parasitic feedback around the comparators.
- 4) Solder the devices directly to the printed circuit board instead of using a socket.
- 5) Minimize input impedance.
- 6) For slowly varying inputs, use a small capacitor (~1000pF) across the inputs to improve stability.

IR Receiver

Figure 4 shows an application using the MAX975 as an infrared receiver. The infrared photodiode creates a current relative to the amount of infrared light present. This current creates a voltage across R_D . When this voltage level crosses the voltage applied by the voltage divider to the inverting input, the output transitions. If the photodiode is not receiving enough signal to cause transitions on the MAX975's output, STAT is used as a loss-of-signal indicator. R_3 adds additional hysteresis for noise immunity.

Single/Dual, +3V/+5V Dual-Speed Comparators with Auto-Standby

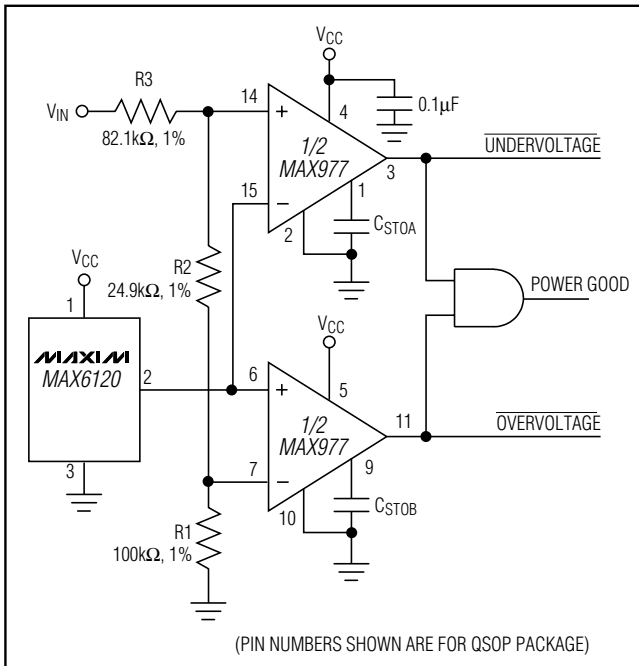

Figure 5. Window Comparator

Window Comparator

The MAX977 is ideal for making a window detector (undervoltage/overvoltage detector). The schematic shown in Figure 5 uses a MAX6120 reference and component values selected for a 2.0V undervoltage threshold and a 2.5V overvoltage threshold. Choose different thresholds by changing the values of R1, R2, and R3. OUTA provides an active-low undervoltage indication, and OUTB gives an active-low overvoltage indication. ANDing the two outputs provides an active-high, power-good signal. The design procedure is as follows:

- 1) Select R1. The leakage current into INB- is normally 100nA, so the current through R1 should exceed 10µA for the thresholds to be accurate. R1 values in the 50kΩ to 100kΩ range are typical.
- 2) Choose the overvoltage threshold (V_{O_{TH}}) when V_{IN} is rising, and calculate R2 and R3 with the following formula:

$$R2 + R3 = R1 \times [V_{OTH} / (V_{REF} + V_H) - 1]$$
 where V_H = 1/2V_{HYST}.
- 3) Choose the undervoltage threshold (V_{U_{TH}}) when V_{IN} is falling, and calculate R2 with the following formula:

$$R2 = (R1 + R2 + R3) \times [(V_{REF} - V_H) / V_{UTH}] - R1$$
 where V_H = 1/2V_{HYST}.

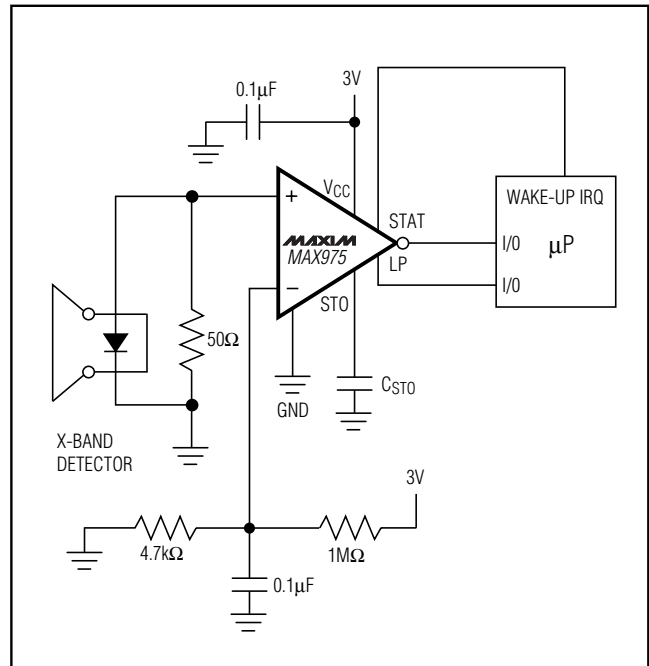

Figure 6. Toll-Tag Reader

- 4) Calculate R3 with the following formula:

$$R3 = (R2 + R3) - R2$$

- 5) Verify the resistor values. The equations are as follows:

$$V_{OTH} = (V_{REF} + V_H) \times (R1 + R2 + R3) / R1$$

$$V_{UTH} = (V_{REF} - V_H) \times (R1 + R2 + R3) / (R1 + R2)$$

Toll-Tag Circuit

The circuit shown in Figure 6 uses a MAX975 in a very low standby-power AM demodulator circuit that wakes up a toll tag (part of an automated roadway toll-collection system). This application requires very long standby times with brief and infrequent interrogations. In the awake state, it is capable of demodulating the typical 600kHz AM carrier riding on the 2.4GHz RF signal. In this state, the comparator draws its 250µA high-speed current. After communications have ceased, or when instructed by the microcontroller, the comparator returns to its low-power state. The comparator draws only 3µA in this state, while monitoring for RF activity. Typically, this application requires two comparators and a discrete power-management and signal-switchover circuit. The MAX975 circuit is smaller, simpler, less costly, and saves design time.

Single/Dual, +3V/+5V Dual-Speed Comparators with Auto-Standby

Pin Configurations

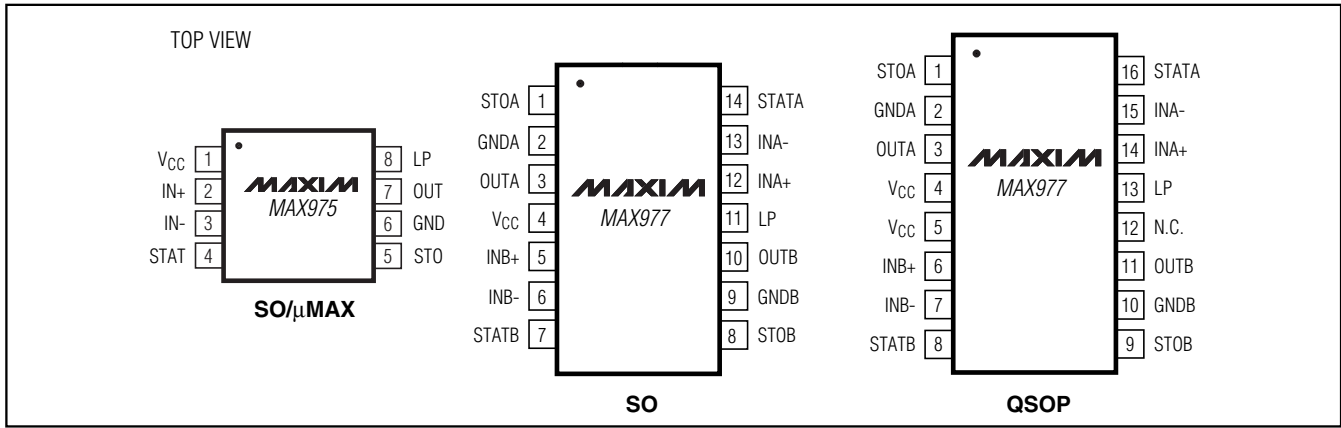

MAX975/MAX977

Chip Information

TRANSISTOR COUNT: 522 (MAX975)
1044 (MAX977)

Single/Dual, +3V/+5V Dual-Speed Comparators with Auto-Standby

Package Information

(The package drawing(s) in this data sheet may not reflect the most current specifications. For the latest package outline information go to www.maxim-ic.com/packages.)

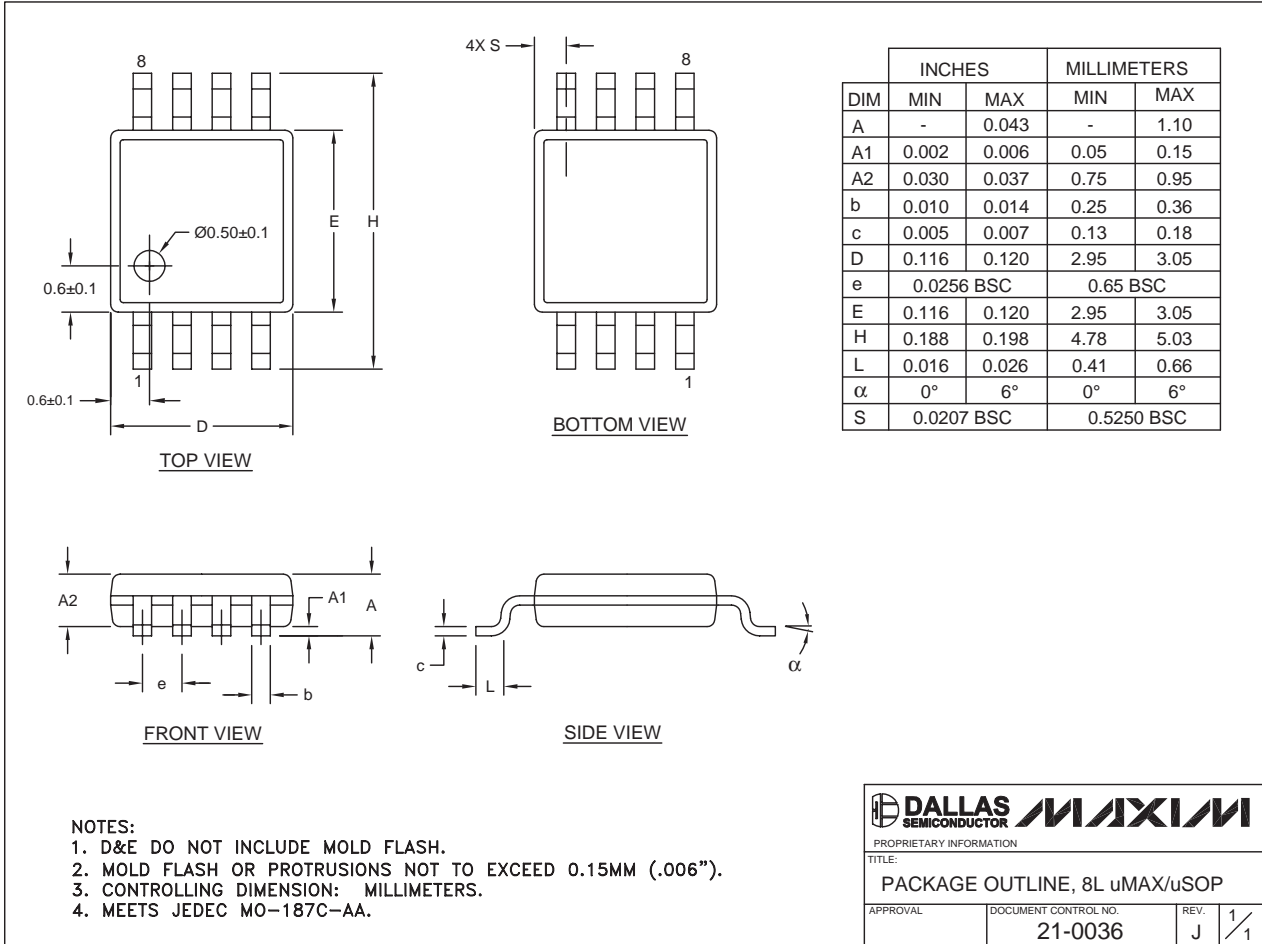

8LUMAXDEFS

Single/Dual, +3V/+5V Dual-Speed Comparators with Auto-Standby

Package Information (continued)

(The package drawing(s) in this data sheet may not reflect the most current specifications. For the latest package outline information go to www.maxim-ic.com/packages.)

MAX975/MAX977

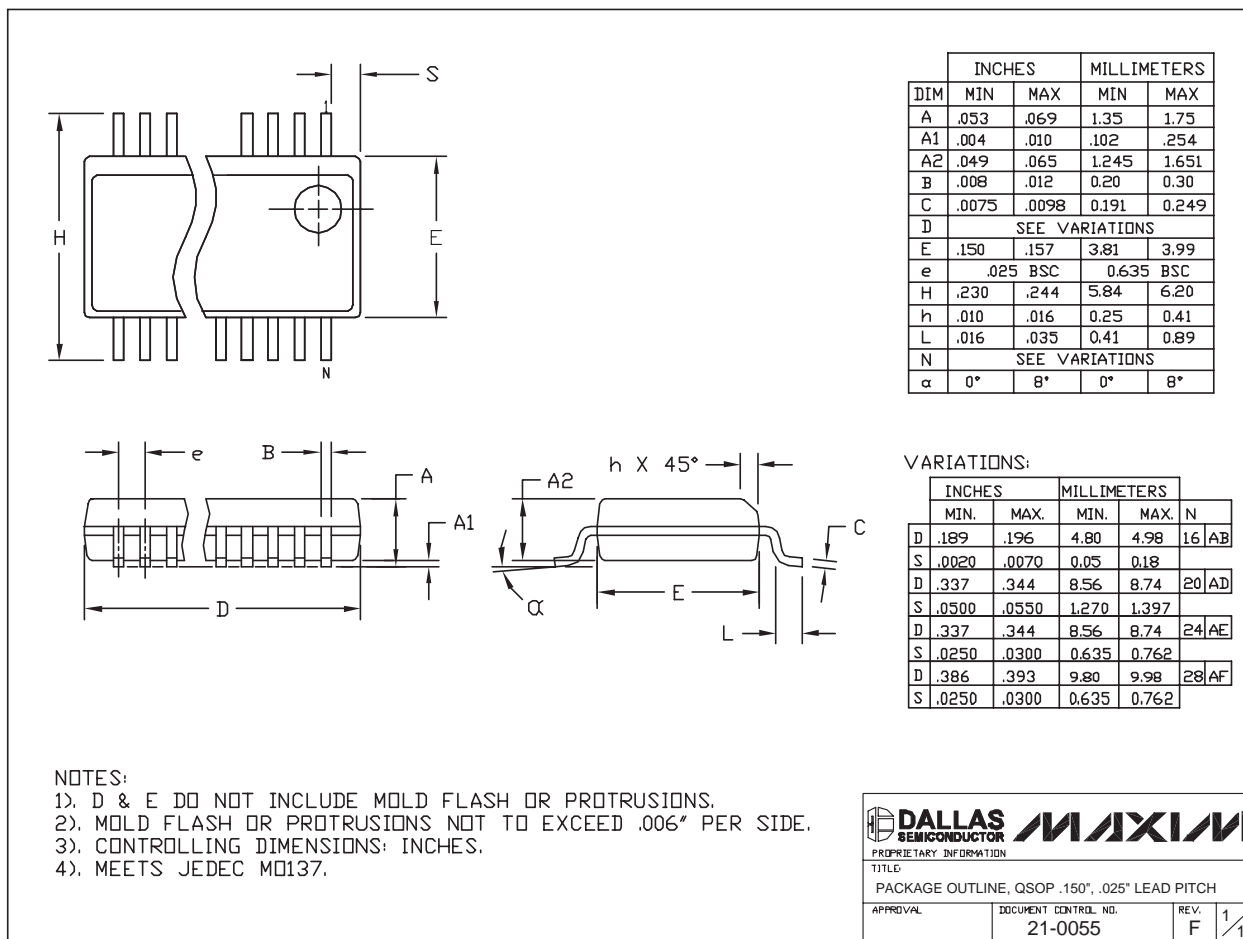

Revision History

Pages changed at Rev 2: 1, 2, 6, 7, 10, 14-16

Maxim cannot assume responsibility for use of any circuitry other than circuitry entirely embodied in a Maxim product. No circuit patent licenses are implied. Maxim reserves the right to change the circuitry and specifications without notice at any time.

Maxim Integrated Products, 120 San Gabriel Drive, Sunnyvale, CA 94086 408-737-7600 17